



BATCHING  
PLANTS  
FOR PRECAST









# MORE THAN 50 YEARS OF INNOVATION AT THE SERVICE OF THE BUILDING INDUSTRY

More than 50 years in business have taught us that only by forging a firm link between the client's experience and dynamic design and manufacturing we can produce quality products that fully meet market demands.

The high level of know-how of our workforce ensures complete control of all processes, from design to the after-sales service.

That is why we are a reliable partner in the development of solutions for precast factories - before, during and after the sale.



# DESIGN, SERVICE AND RESPECT FOR THE ENVIRONMENT

The design of the batching plants and equipment, tailored to the requirements of individual building yards, prefabrication plants and concrete safe facilities, is the brainchild of the efficient and flexible organization of the ORU engineering department.



The rigidly selected staff, its constant dedication to quality, the continuous technological innovations and the application of rigid controls have enabled the company to reach high levels of performance and to obtain, in 1996, the ISO 9001 certification.



CONSTANT RESEARCH AND INNOVATION





ORU's service department, through the experience, responsibility and competence of its personnel and its dense network of service centers, makes it possible to promptly meet the different requirements of individual customers.

Over 22,000 customers worldwide have shown their preference for ORU products and have been able to verify the quality and reliability of the company's design and service departments.

In addition, with a constant concern for the requirements of the environment and the ecological aspect of its products, ORU designs and builds certified concrete batching plants and equipment with noise and dust emission levels below the limits required by the relative standards.

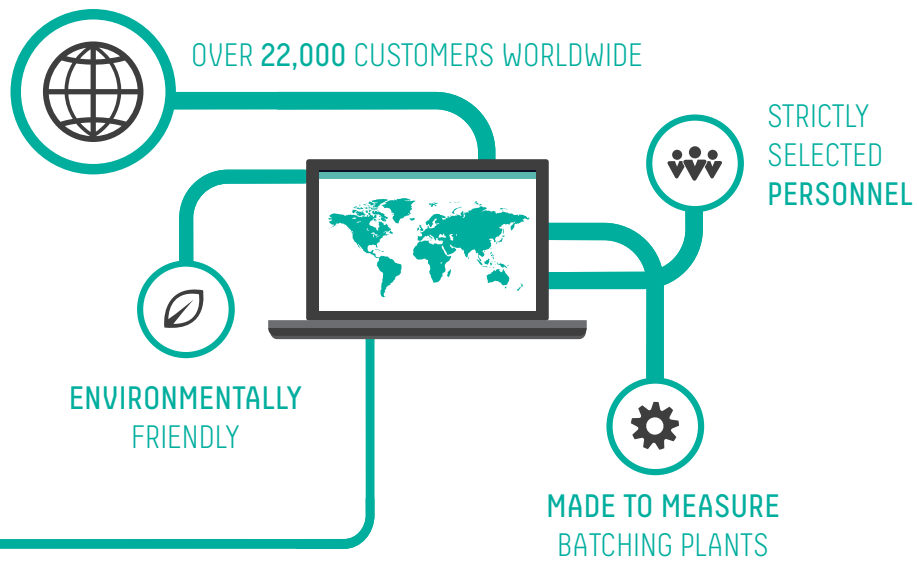







# PRECAST



## AGGREGATES SYSTEM

*Horizontal | Vertical | Radius lift arm*



## DISTRIBUTION

*Overhead concrete distribution systems*



## MIXING

*Planetary pan mixers and twin-shaft mixers*



## MANAGEMENT SYSTEMS

*Customized engineering of integrated  
management systems*

# HORIZONTAL

## BATCHING PLANT FOR PRECAST FACTORIES





## STORAGE



The ORU horizontal batching plants are designed and built for long operation even in extreme working conditions, a standard characteristic of every ORU product.

Particular design features make these machines easy to install, safe to operate and low in their maintenance requirements.

The standardization of some elements common to all versions, the modular construction, the different equipment combinations, and the vast range of accessories make it possible to increase the versatility of the batching plant, thus making it the ideal solution for any concrete batching requirement.

The **ORU horizontal** precast batching plants are the ideal solution in the cases requiring:

- **Custom configurations**
- **Modularity and high number of aggregates**
- **Easy and fast mounting**
- **Low environmental impact**

To respond to the many requirements of building yards of different types (for clearances, dimensions, etc.), ORU proposes an accurate study capable of resolving the most diverse problems: from the installation of the batching plant to the delivery of the concrete (distribution, etc.), to the process of automation and prearrangement of the safety equipment, in compliance with applicable legislation.

## PRODUCT RANGE

**ORULOGIK L**

**ORULOGIK B**

**ORUROME CZ**



## MODULAR CONSTRUCTION AND HOT GALVANIZING

The ORU aggregates storage units are made from modular elements which allow the almost complete interchangeability in the design phase and production ensuring the standardization of the product and significantly reducing the production time and allowing any future extensions of the storage unit without structural changes to existing elements.

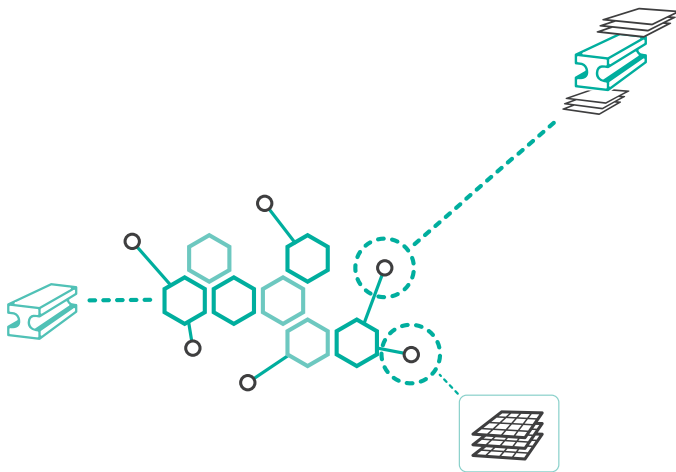

The main structures are hot galvanized and this treatment ensures total protection from corrosive agents to which the plants are continuously subject and therefore a higher durability.

On request, the equipment can also be provided with paint coating over the galvanized surfaces.





## AGGREGATE STORAGE AND COVERING

The dimensions of the compartments are such as to allow a considerable filling capacity, and the modularity of the hoppers simplifies their installation. The aggregate storage bin charging system is made to meet the specific requirements of each building yard.





## PNEUMATIC DISCHARGE GATES

The aggregate is fed from the hoppers through electro-pneumatic discharge gates, with double speed in the closing phase. On request, the discharge systems can be of different type (by belt conveyor, by vibrating conveyors, etc.) and tailored to the requirements of the customer. When the aggregate is discharged through electro-pneumatic gates, the use of an adjustable mechanical limit switch controlling the opening of the discharge gate guarantees greater batching accuracy.

The parts that undergo the aggregates friction, like discharging cones and the weighing hopper, are equipped with interchangeable wearing plates that ensure the structure durability.



## BELTUP

Thanks to our BELTUP (patented) scale belt, costly concrete works are not needed (no pillars and no wells) and the storage bin loading point remains extremely low.

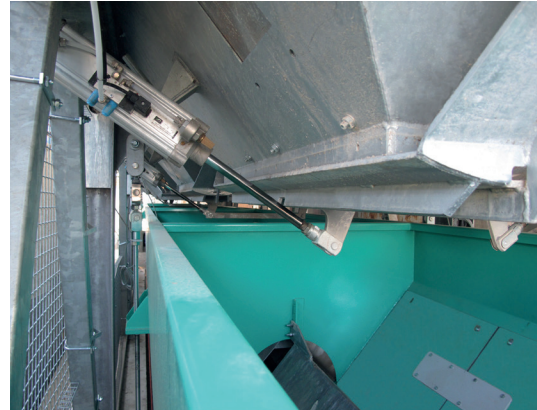

## VIBRATING SYSTEM

To facilitate the discharge of particularly cohesive materials, vibrators have been installed on independent plates applied with a particular system to avoid negative stresses on the plant structure.

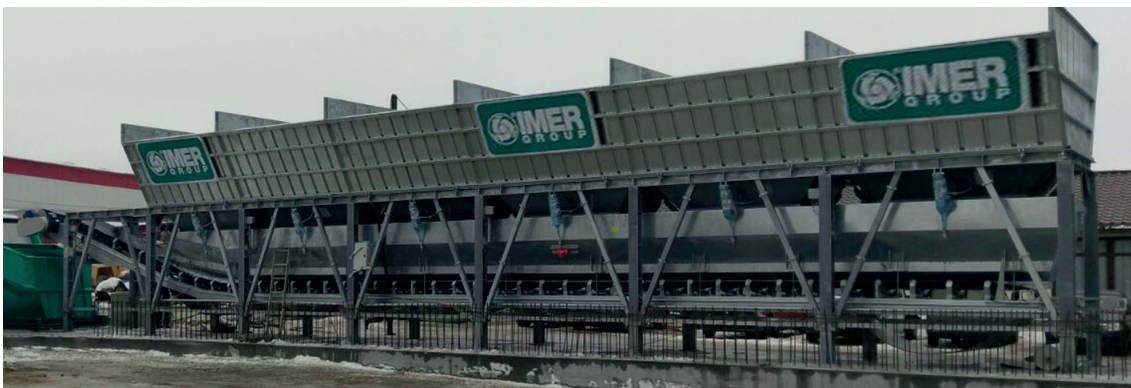

## VIBRATING EXTRACTOR

The vibrating extractors are machines consisting of a spring-supported steel-plate conduit used to discharge the aggregate through the movement generated by electromechanical or electromagnetic vibrators. The machines are suitable for discharging aggregate of any grain size. The distinctive characteristics are metering precision, low noise, and practically maintenance-free operation.



## BELT EXTRACTOR

When high metering accuracy is necessary in feeding materials such as sand or crushed stone, the use of the extracting conveyor belt is a sure solution to the problem. The machine is equipped with a device signalling the presence of material, a flow regulator, and a manual cut-off gate for routine maintenance.

## LOADING CELLS

The aggregate and cement weighing system uses load cells applied directly to the supports of the respective hoppers, thus achieving an accurate and reliable weight measurement. The weighing system with load cells is type approved according to CE standards.

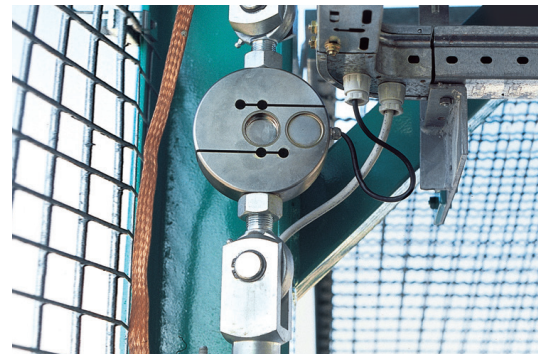

## WEIGHING TROLLEY

As an alternative to the aggregates weighing belt, especially for plants with long storage units, we can provide our system with a weighing trolley.



# TECHNICAL CHARACTERISTICS



Aggregates storage unit ORU ROME CZ

## STORAGE UNIT ORU ROME CZ

**CZ3**

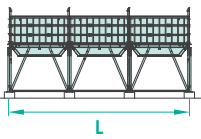

**CZ4**

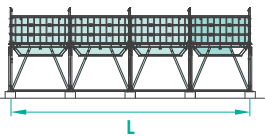

**CZ5**

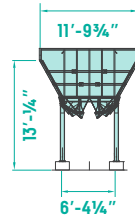
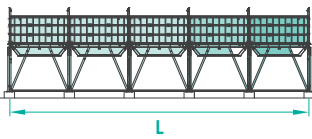

**CZ6**

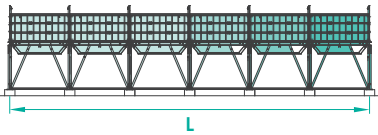

**CZ7**

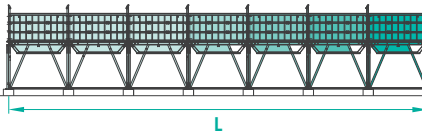

**CZ8**

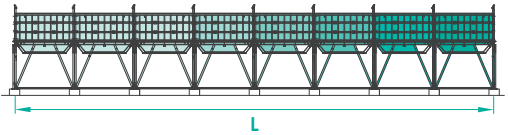

Storage (yd <sup>3</sup> )	L (ft)	WEIGHING BELT				
<b>CZ3</b>						
70	28.5	Width (ft)	2-3½	2-7½	-	-
		Flow (yd <sup>3</sup> /h)	248.5	348	-	-
		Length (ft)	30-9¼	30-9¼	-	-
<b>CZ4</b>						
94	38.0	Width (ft)	2-3½	2-7½	3-3½	3-11¼
		Flow (yd <sup>3</sup> /h)	248.5	348	458	601.5
		Length (ft)	40-3½	40-3½	41-8½	41-8½
<b>CZ5</b>						
118	47.6	Width (ft)	2-3½	2-7½	3-3½	3-11¼
		Flow (yd <sup>3</sup> /h)	248.5	348	458	601.5
		Length (ft)	49-10¾	49-10¾	51-2½	51-2½

Storage (yd <sup>3</sup> )	L (ft)	WEIGHING BELT				
<b>CZ6</b>						
141	57.1	Width (ft)	-	2-7½	3-3½	3-11¼
		Flow (yd <sup>3</sup> /h)	-	348	458	601.5
		Length (ft)	-	59-4¾	60-8½	60-8½
<b>CZ7</b>						
165	761.2	Width (ft)	-	2-7½	3-3½	3-11¼
		Flow (yd <sup>3</sup> /h)	-	348	458	601.5
		Length (ft)	-	68-10¾	70-2½	70-2½
<b>CZ8</b>						
188	856.3	Width (ft)	-	2-7½	3-3½	3-11¼
		Flow (yd <sup>3</sup> /h)	-	348	458	601.5
		Length (ft)	-	78-4¾	79-8½	79-8½



Aggregates storage unit ORU LOGIK WB



Aggregates storage unit ORU LOGIK WL





### STORAGE UNIT ORULOGIK L3/4/5

L3

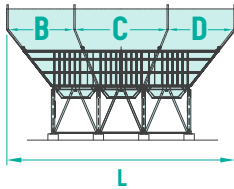

L4

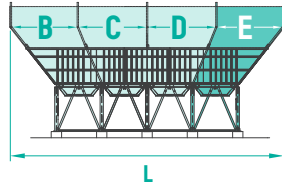

L5

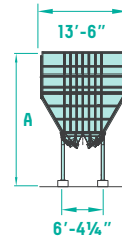
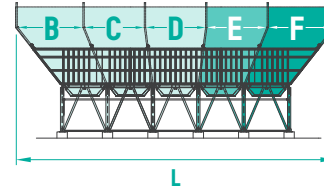

Storage (yd <sup>3</sup> )	Extension walls (ft)	A (ft)	L (ft)	B (ft)	C (ft)	D (ft)	E (ft)	F (ft)
<b>L3</b>								
85	0	14-3/4	31-5/4	9-3/4	12-4/4	9-3/4		
137	3-3 1/2	17-6/4	36-10/4	10-7/4	15-3	10-7 1/2		
196	6-6 3/4	20-9/4	35-10/4	10-4/4	14-7 1/2	10-4/4		
<b>L4</b>								
105	0	14-3/4	38-7/4	9-3/4	9-8/4	8-9/4	9-3/4	
170	3-3 1/2	17-6/4	44-1 1/2	10-7/4	10-7/4	11-1 1/2	10-7/4	
235	6-6 3/4	20-9/4	43-1/4	10-4/4	10-9/4	10-9/4	10-4/4	
<b>L5</b>								
131	0	14-3/4	14	9-3/4	8-9/4	8-9/4	8-9/4	9-3/4
196	3-3 1/2	17-6/4	16-7/4	10-7/4	9-8/4	9-8/4	9-8/4	10-7/4
275	6-6 3/4	20-9/4	15-4/4	10-4/4	9-6 1/2	9-6 1/2	9-6 1/2	10-4/4

WEIGHING BELT	Straight Belt	Beltup
<b>L3</b>		
Width (ft)	3-11/4	3-11/4
Flow (yd <sup>3</sup> /h)	601.5	601.5
Length (ft)	24-3/4	29-10/4
<b>L4</b>		
Width (ft)	3-11/4	3-11/4
Flow (yd <sup>3</sup> /h)	601.5	601.5
Length (ft)	32-5/4	37-3/4
<b>L5</b>		
Width (ft)	3-11/4	3-11/4
Flow (yd <sup>3</sup> /h)	601.5	601.5
Length (ft)	40-4/4	4-3 1/2

### STORAGE UNIT ORULOGIK B4/5/6

B4

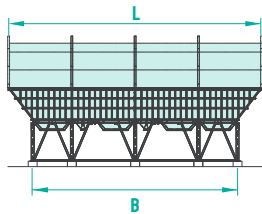

B5

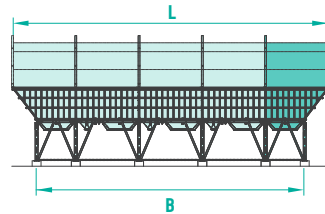

B6

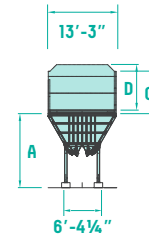
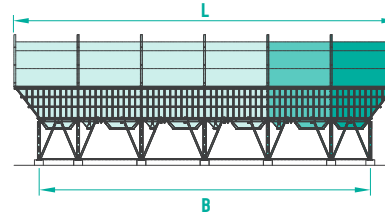

Storage (yd <sup>3</sup> )	Extension walls (ft)	A (ft)	B (ft)	C (ft)	D (ft)	L (ft)
<b>B4</b>						
128	0	14-5/4		0	0	
160	0	14-5/4		1-7/4	2-3 1/2	
233	3-3 1/2	17-8/4	37-8/4	4-11/4	5-5/4	49-7 1/4
306	6-6 3/4	21		8-2 1/4	8-10/4	
<b>B5</b>						
162	0	14-5/4		0	0	
199	0	14-5/4		1-7/4	2-3 1/2	
290	3-3 1/2	17-8/4	49-4/4	4-11/4	5-5/4	58-2 3/4
385	6-6 3/4	21		8-2 1/4	8-10/4	
<b>B6</b>						
196	0	14-5/4		0	0	
241	0	14-5/4		1-7/4	2-3 1/2	
350	3-3 1/2	17-8/4	61	4-11/4	5-5/4	69-10 1/2
460	6-6 3/4	21		8-2 1/4	8-10/4	

WEIGHING BELT	Straight Belt	Beltup
<b>B4</b>		
Width (ft)	3-11/4	3-11/4
Flow (yd <sup>3</sup> /h)	601.5	601.5
Length (ft)	41-7/4	46-10/4
<b>B5</b>		
Width (ft)	3-11/4	3-11/4
Flow (yd <sup>3</sup> /h)	601.5	601.5
Length (ft)	52-6	58-4/4
<b>B6</b>		
Width (ft)	3-11/4	3-11/4
Flow (yd <sup>3</sup> /h)	601.5	601.5
Length (ft)	63-7/4	69-10 1/2



# VERTICAL

## BATCHING PLANT FOR PRECAST FACTORIES

In accordance with the general philosophy underlying ORU's commercial policy, the vertical batching plants for prefabrication operations are designed to provide an answer to specific requirements.

The choice of a vertical batching plant presupposes a greater output compared to a horizontal plant and offers an excellent possibility of controlling noise and dust emissions.

The vertical system requires the material to be raised, but thereafter the whole process takes place in a closed environment and by gravity, with distinct advantages in terms of energy savings, less wear, and reduced external noise levels.

The combination of the most modern technologies with trained personnel makes it possible to obtain a system capable of reconciling the productivity and quality of the product, and best for meeting operating demands.

### PRODUCT RANGE

ORUZENITH MID6

ORUZENITH MID8

ORUZENITH BIG10

The **ORU ZENITH** vertical batching plants are the ideal solution in the cases requiring:

- **High productivity**  
(with different aggregate types)
- **High storage capacity**  
and reduced spaces
- **A variety of functions**  
(both for the pre-cast industry  
and for ready-mix concrete)
- **Functionality** (thanks to the  
philosophy of modular construction).





## MODULAR CONSTRUCTION AND HOT GALVANIZING

To simplify construction and handling, and cut down delivery times, ORU has standardized some elements that are common to all versions.

These elements include walls, extension walls and partitions, aggregate hoppers, the weighing conveyor belt frame, and the frame of the hopper with two discharge gates.

The support structure and the aggregate storage bins are hot galvanized.



This type of surface treatment of the metal ensures an excellent protection against corrosion in any environmental condition, and therefore a longer life and better inalterability of the product.

On request, the equipment can also be provided with paint coating over the galvanized surfaces.







It consists of a cylindrical silo whose lower part has the shape of a truncated cone and which is characterized by:

- **Rationality of aggregate flowing**
- **Easy conveying into the weighing hopper even in the presence of a great number of aggregates**
- **Possibility of conveying the water coming out of very moist aggregates into collecting areas: it is indispensable to collect the water both for carrying out high-quality batches and for the environmental respect and cleaning**
- **Simple assembly: the silos are constructed by means of galvanized modular panels (both the cylindrical part and the truncated cone) of suitable dimensions in order to facilitate their transport and assembly; each panel is 6 feet high in order to allow a quick and safe assembly on the ground, thus avoiding the use of scaffolds and cranes**
- **Elimination of all the aggregate residues thanks to its shape**
- **Easy maintenance: in the lower truncated-conical part where the extraction mouths are positioned, a crawl space (one for each compartment) allows the internal maintenance**
- **Sturdiness of the pneumatically-operated extraction mouths (on request: wear-resistant plates)**



## AGGREGATE STORAGE AND COVERS

The dimensions of the compartments are such as to allow a considerable filling capacity, and the modularity of the hoppers simplifies their installation. The aggregate storage bin charging system is made to meet the specific requirements of each building yard.

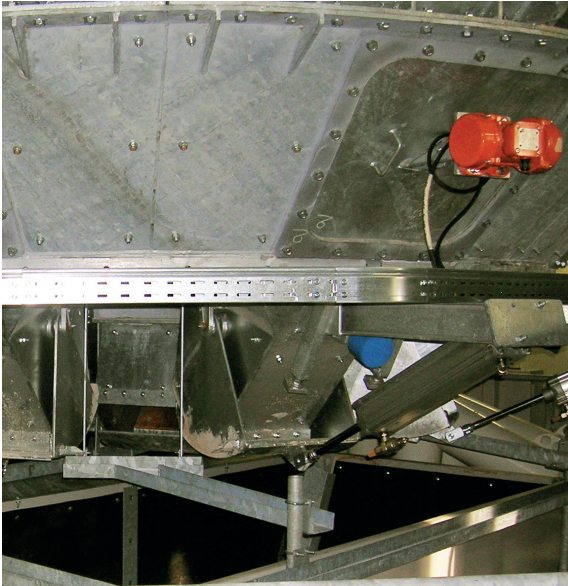

## VIBRATING SYSTEM

To facilitate the discharge of particularly cohesive materials, vibrators have been installed on independent plates applied with a particular system to avoid negative stresses on the plant structure.

## PNEUMATIC DISCHARGE GATES

The aggregate is fed from the hoppers through electro-pneumatic discharge gates, with double speed in the closing phase. On request, the discharge systems can be of different type (by belt conveyor, by vibrating conveyors, etc.) and tailored to the requirements of the customer. When the aggregate is discharged through electro-pneumatic gates, the use of an adjustable mechanical limit switch controlling the opening of the discharge gate guarantees greater batching accuracy.

## EXTRACTOR BELT

When high metering accuracy is necessary in feeding materials such as sand or crushed stone, the use of the extracting conveyor belt is a sure solution to the problem. The machine is equipped with a device signalling the presence of material, a flow regulator, and a manual cut-off gate for routine maintenance.

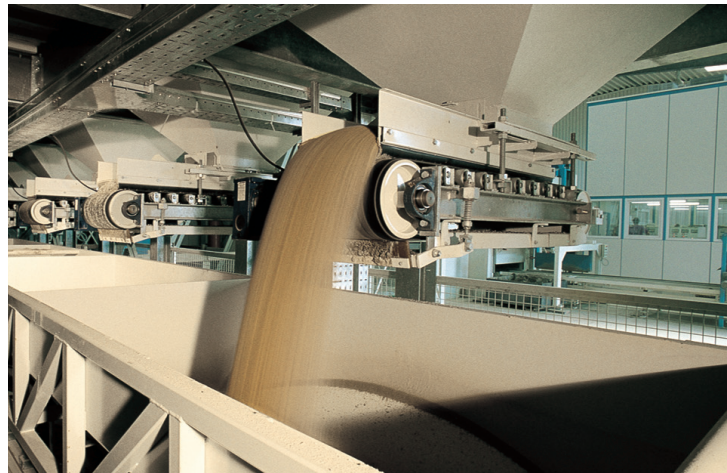



## TOP PERFORMANCE

### DOUBLE SECTION

The vertical plants ORU ZENITH can be equipped in the dual mixer configurations with double independent weighing systems to ensure maximum hourly production.

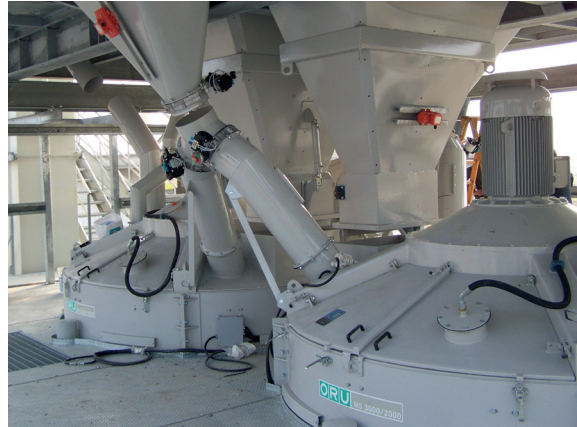

## STORAGE BINS

The aggregates storage consists of a cylindrical silo whose lower part has a truncated-conical shape and which is characterized by:

- **Rationality of aggregate flowing**
- **Elimination of all the aggregate residues thanks to its shape**
- **Easy conveying into the weighing hopper even in the presence of a great number of aggregates**

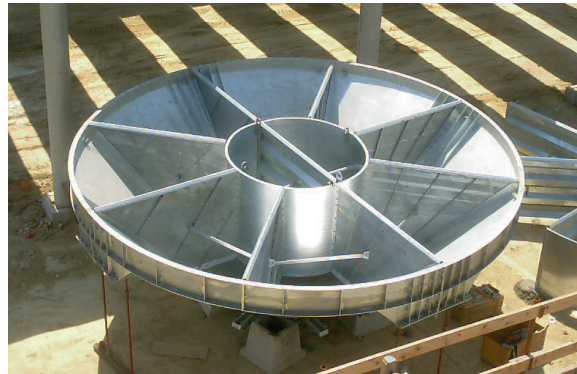

## WEIGHING SYSTEM

The aggregate and cement weighing system uses load cells applied directly to the supports of the respective hoppers, thus achieving an accurate and reliable weight measurement. The weighing system with load cells is type approved according to CE standards.



ORUZENITH MID6

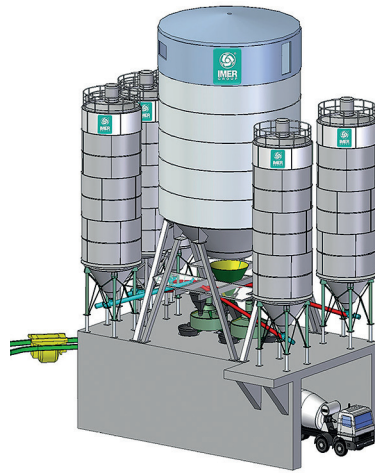

ORUZENITH MID8

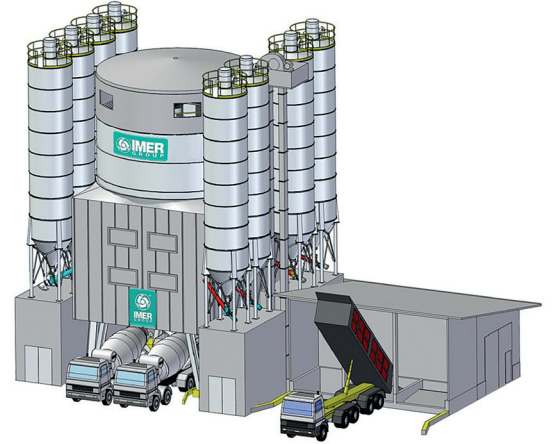

ORUZENITH BIG10

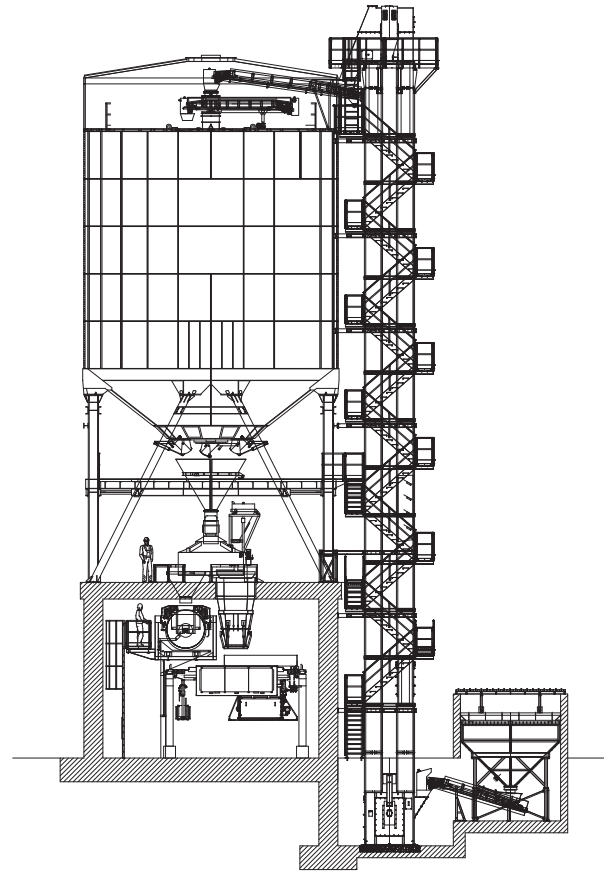
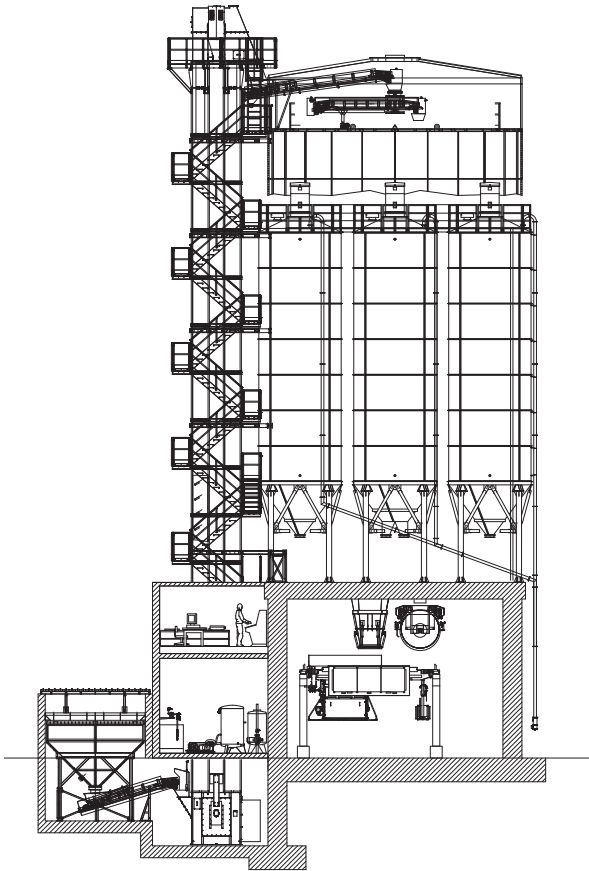

## TECHNICAL CHARACTERISTICS

		ORU ZENITH MID6	ORU ZENITH MID8	ORU ZENITH BIG10
Aggregates storage bins	n.	6 - 12	8 - 16	10 - 18
Aggregates storage capacity	yd <sup>3</sup>	209 - 510	353 - 1,020	628 - 1,897
Aggregates weighing hopper capacity	tons	2.65 - 11		
Cement weighing hopper capacity	tons	0.66 - 2.65		
Approved weighing system		Loading cells		
Water system		By weight or by electromagnetic flow meter		
Mixer		Planetary (ORU MS) - Twin shaft (ORU MD)		

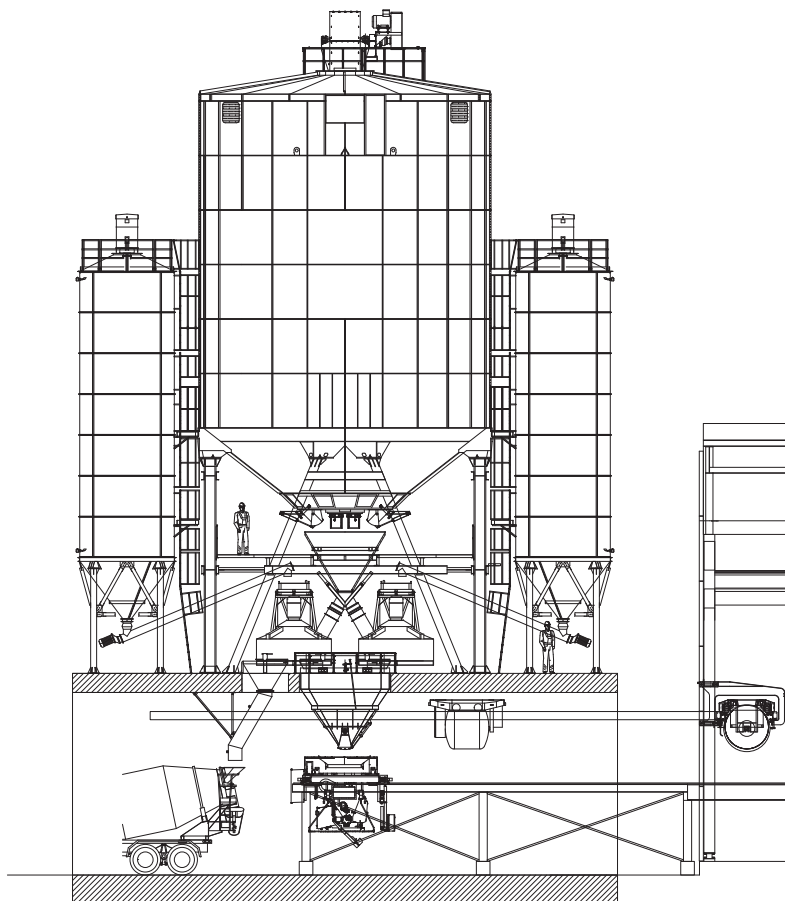







## DISTRIBUTION

# OVERHEAD CONCRETE DISTRIBUTION

The ORU overhead concrete transportation system is the result of an engineering effort aimed at achieving maximum functionality and safety.

The choice of the ORU concrete distribution system enables prefabrication operators to draw the greatest advantage from the production capacities of their plants and, at the same time, to achieve a significant

reduction of the labor and costs involved in the transportation of the concrete.

The ORU transportation system makes it possible to maintain the characteristics of concrete intact up to the casting phase. Each phase of operation takes place in full compliance with applicable safety standards.

## PRODUCT RANGE

ORUFLY EDR 1000/1500/2000

ORUFLY EDR-BV 1000/1500/2000

ORUFLY EDC 1000/1500/2000

ORUFLY EDC-BV 1000/1500/2000



## MAXIMUM COMPACTNESS

ORU FLY is available in various versions: for **STRAIGHT RAILS (ORUFLY EDR)** and for **CURVED RAILS (ORUFLY EDC)**, with a rotating discharge hopper (ideal for fluid concrete) or through discharge shutters (**ORUFLY BV**).

The shape of the hopper makes it possible to carry all types of concrete without any wasted space. The compact length and height of the skip also favor the use of the overhead travelling skip in existing plants.



## VARIABLE SPEED ELECTRICAL TRANSLATION

The overhead skip is provided with a variable electromechanical system. This system makes it possible to vary the maximum speeds, the speed on a curve or an incline, the approach speed. The discharge system operated by a hydraulic unit ensures the skip discharges even in the absence of supply voltage.







## OVERHEAD SKIP ORU FLY EDR-EDC

The discharge with rotating skip is particularly suitable for fluid concrete, as this type of hopper guarantees maximum tightness, and the discharge system is particularly versatile. The skip can rotate to the right or left and can be stopped at any angle. This type of rotation allows a thorough washing of the hopper.

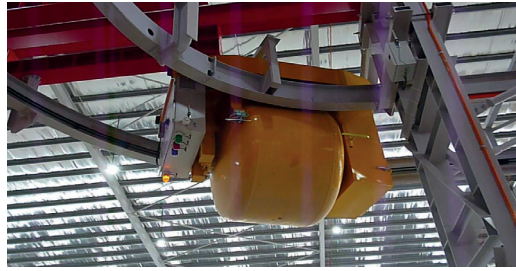

## OVERHEAD SKIP ORU FLY EDR-EDC BV

The discharge with a twin-valve hopper is particularly suitable for semi-dry and, especially, dry concrete. With this type of hopper it is possible to feed paired hoppers.



## CUSTOMIZED ORU FLY

We develop customized solutions to meet every need of our customers:

- uphill runways' solutions
- multi-hopper skip
- mobile concrete buckets
- customized hopper design

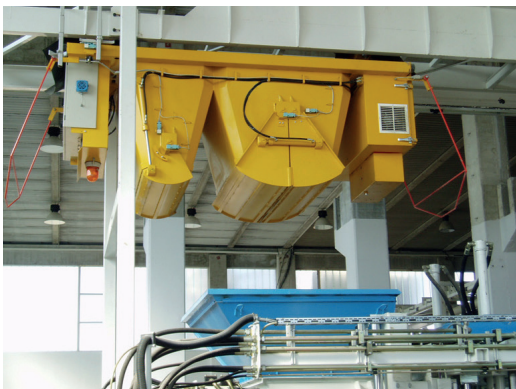

## ORUFLY EDR

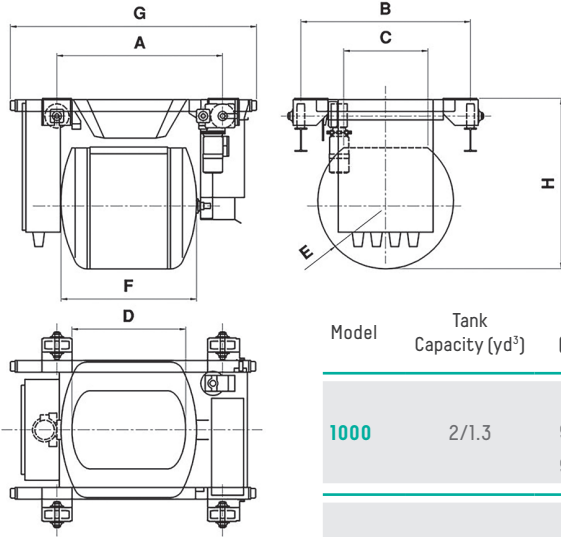

MODEL	DIMENSIONS (IN)							
	A	B	C	D	E	F	G	H
<b>1000</b>	67	69	34	46-½	27-½	55	100	69.5
<b>1500</b>	74	79	40	40	31-½	63	108	75
<b>2000</b>	77	81	42-½	53-½	35-½	64	116	84

Model	Tank Capacity (yd³)	Speed (ft/min)	Drive wheels (n)	Translation motors power (hp)	Hydraulic unit power (hp)	Bucket weight (Empty - tons)	Bucket weight (Loaded - tons)
<b>1000</b>	2/1.3	66-197	2	4.0	4.0	2.0	4.5
		99-394	2	7.5	4.0	2.0	4.5
		99-590	2	10.0	4.0	2.0	4.5
<b>1500</b>	3/2	66-197	2	5.5	5.5	2.0	6.0
		99-394	2	10.0	5.5	2.0	6.0
		99-590	2	10.5	5.5	2.0	6.0
<b>2000</b>	4/2.6	66-197	2	10.0	5.5	2.5	8.0
		99-394	2	12.5	5.5	2.5	8.0
		99-590	2	15.0	5.5	2.5	8.0

## ORUFLY EDR-BV

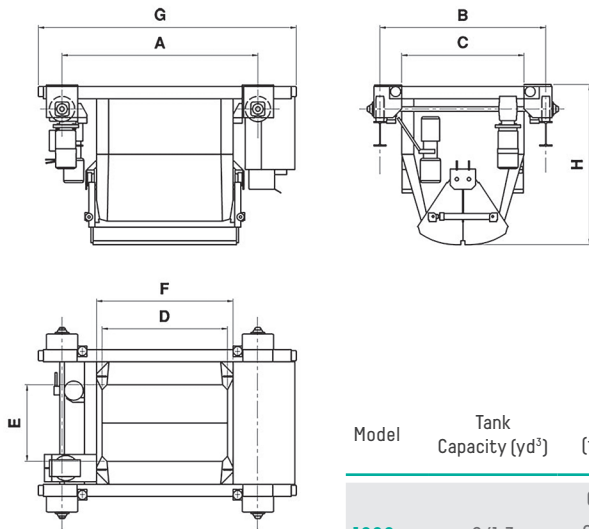

MODEL	DIMENSIONS (IN)							
	A	B	C	D	E	F	G	H
<b>1000</b>	76	64-½	48	49	30	53	100	62
<b>1500</b>	79	79-½	57-½	39	57-½	59	113	57
<b>2000</b>	92-½	81	57	39	57	73	127	74-½

Model	Tank Capacity (yd³)	Speed (ft/min)	Drive wheels (n)	Translation motors power (hp)	Hydraulic unit power (hp)	Bucket weight (Empty - tons)	Bucket weight (Loaded - tons)
<b>1000</b>	2/1.3	66-197	2	4.0	4.0	1.5	4.0
		99-394	2	7.0	4.0	1.5	4.0
		98-492	2	10.0	4.0	1.5	4.0
<b>1500</b>	3/2	66-197	2	5.0	4.0	2.0	6.0
		99-394	2	10.0	4.0	2.0	6.0
		98-492	2	10.0	4.0	2.0	6.0
<b>2000</b>	4/2.6	66-197	2	10.0	4.0	2.5	8.0
		99-394	2	12.0	4.0	2.5	8.0
		98-492	2	15.0	4.0	2.5	8.0



## ORUFLY EDC

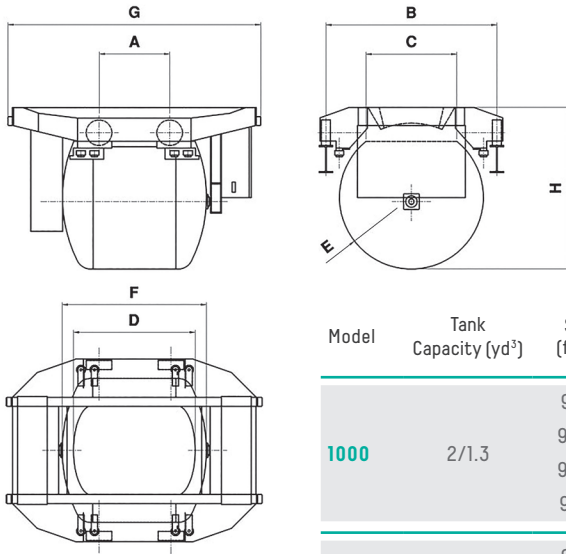

MODEL	DIMENSIONS (IN)							
	A	B	C	D	E	F	G	H
1000	31-½	71	34	46-½	27-½	55	99	65
1500	31-½	75	40	53	31-½	63	111	71
2000	31-½	79	42-½	53-½	35-½	64	120	83

Model	Tank Capacity (yd <sup>3</sup> )	Speed (ft/min)	Drive wheels (n)	Translation motors power (hp)	Hydraulic unit power (hp)	Bucket weight (Empty - tons)	Bucket weight (Loaded - tons)
1000	2/1.3	98-197	2	2x2	4.0	1.6	4.41
		98-394	2	4x2	4.0	1.7	4.46
		98-590	2	4x2	4.0	1.7	4.46
		98-787	4	3x4	4.0	1.7	4.63
1500	3/2	98-197	2	4x2	5.5	2.0	6.28
		98-394	2	5x2	5.5	2.0	6.28
		98-590	2	5x2	5.5	2.0	6.28
		98-787	4	4x4	5.5	2.0	6.34
2000	4/2.6	98-197	2	4x2	5.5	2.5	7.83
		98-394	2	7x2	5.5	2.5	7.88
		98-590	2	7x2	5.5	2.5	7.88
		98-787	4	5x4	5.5	2.5	8.16

## ORUFLY EDC-BV

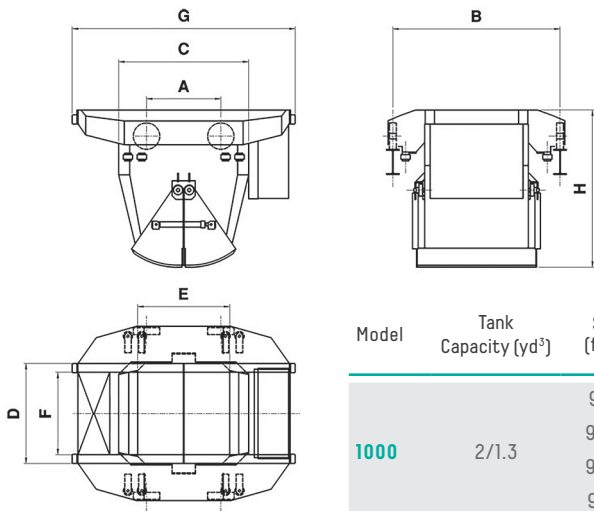

MODEL	DIMENSIONS (IN)							
	A	B	C	D	E	F	G	H
1000	31-½	71	55-½	44	38-½	35	94-½	66-½
1500	31-½	75	59	47	38-½	39	102-½	74-½
2000	31-½	79	63	50	38-½	42-½	108	84

Model	Tank Capacity (yd <sup>3</sup> )	Speed (ft/min)	Drive wheels (n)	Translation motors power (hp)	Hydraulic unit power (hp)	Bucket weight (Empty - tons)	Bucket weight (Loaded - tons)
1000	2/1.3	98-197	2	2x2	4.0	1.65	4.41
		98-394	2	4x2	4.0	1.70	4.46
		98-590	2	4x2	4.0	1.70	4.46
		98-787	4	3x4	4.0	1.87	4.63
1500	3/2	98-197	2	4x2	4.0	1.85	5.99
		98-394	2	5x2	4.0	1.85	5.99
		98-590	2	5x2	4.0	1.85	5.99
		98-787	4	4x4	4.0	2.0	6.15
2000	4/2.6	98-197	2	4x2	4.0	2.16	7.67
		98-394	2	7x2	4.0	2.23	7.74
		98-590	2	7x2	4.0	2.23	7.74
		98-787	4	5x4	4.0	2.40	7.91



The ORU overhead transportation system is generally provided with a casting crane that can be of bridge type, or of semi-portal or portal type, with or without operator on board and with automation features depending on the specific requirements of every customer. The bucket moving in any direction makes it possible to distribute the concrete in formworks of different shapes and sizes without the need of additional lifting or transportation means. On specific request, the bucket discharge system can be of different types: twin-valve, with rotating chutes, with wider mouths for discharging on extruders, with rotary hopper for discharging the concrete in a longitudinal or transversal direction. ORU can in any case supply special casting cranes to suit the requirements of the customer.

### CASTING CRANE WITH VIBRATING EXTRACTOR SYSTEM



### BRIDGE CASTING CRANE



### CONCRETE CASTING CRANE

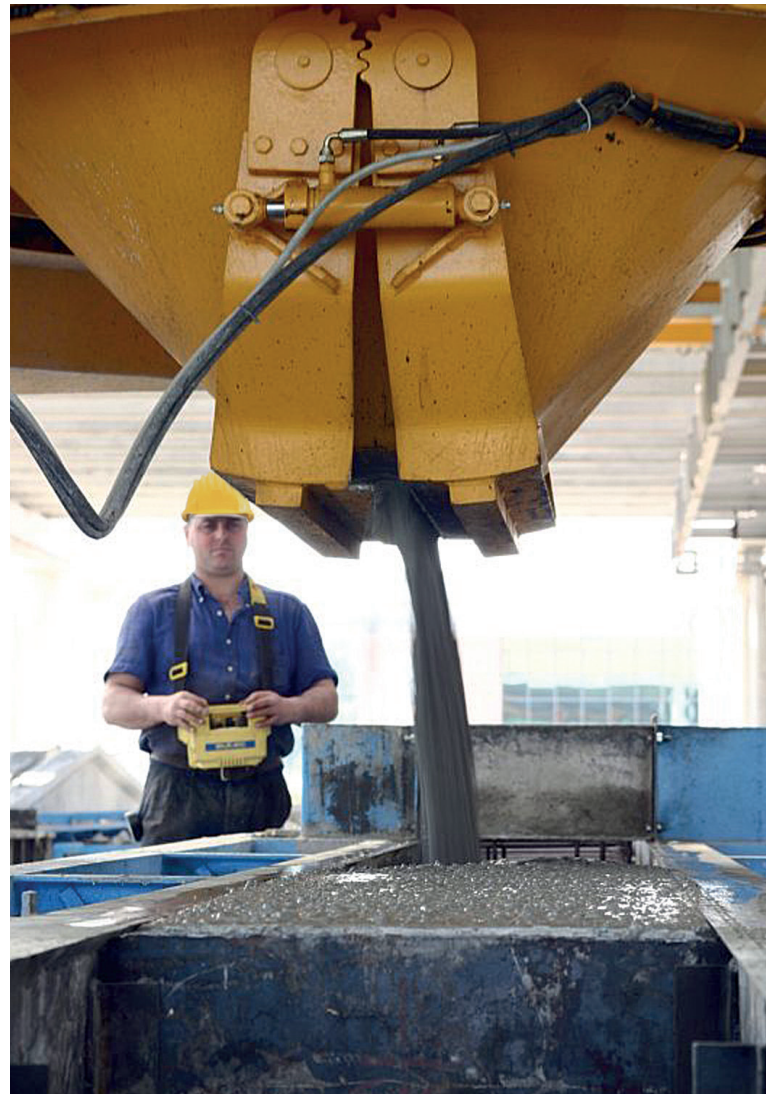

### SEMI-PORTAL AND PORTAL CASTING CRANE





# CASTING SYSTEMS

## CASTING BUCKET COUPLED WITH CRANE



## TRANSLATING BUCKET FOR DOUBLE SPAN



## CASTING CRANE FOR HOLLOW CORE SLABS AND WALLS PRODUCTION WITH EXTRUDER & SLIPFORMER



## TROLLEY-BUCKET ON THE GROUND



## CASTING BUCKET WITH VERTICAL TRANSLATION



# COLOR MIX

DISTRIBUTION



## CONCRETE DISTRIBUTION SYSTEM

In this sector and for this particular product, the IMER Group proposes dynamic solutions able to meet the ongoing evolution of customer requirements. Our R&D and mechanical/electrical engineering departments are heavily committed to assert the group's leadership in the prefabrication sector.

### MANAGEMENT SYSTEM VERSATILITY

The Color Mix is complete with automation that integrates easily with the management software of concrete mixing plants. With the software installed it is possible to operate the equipment in a large variety of modes depending on the type of finished product. It can be combined with any type of plant.

Then it's possible to identify 3 main types of COLOR MIX, which can evolve and adapt to any situation at the job site:

### HORIZONTAL COLOR MIX



The system is basically composed of 3 or 4 mobile hoppers (1), They are placed in line and translates under the discharging gate of the mixer. Each hopper can be loaded with a specific color and it is equipped with a variable dosing belt (2) and a calling probe (4) that ensures the constant filling. The translating extractor belt (3) loads the block machinery. The management of the speed and flow of variables extracting belts and the sequences, allows you to obtain different color mix under total control by the operator.

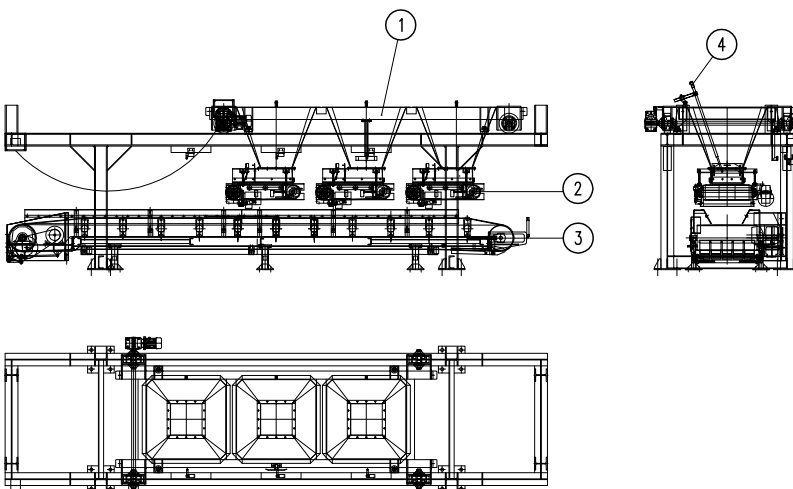



## VERTICAL COLOR MIX

The system is composed of 3 fixed hoppers (1), each one positioned below the corresponding discharge gate of the mixer (max. 3), each one is equipped with a variable flow metering dosing belts (2) and a colling probe (4). The sliding extractor belt (3) ensures the supply of material to the block machinery according to the sequences of the color mix.

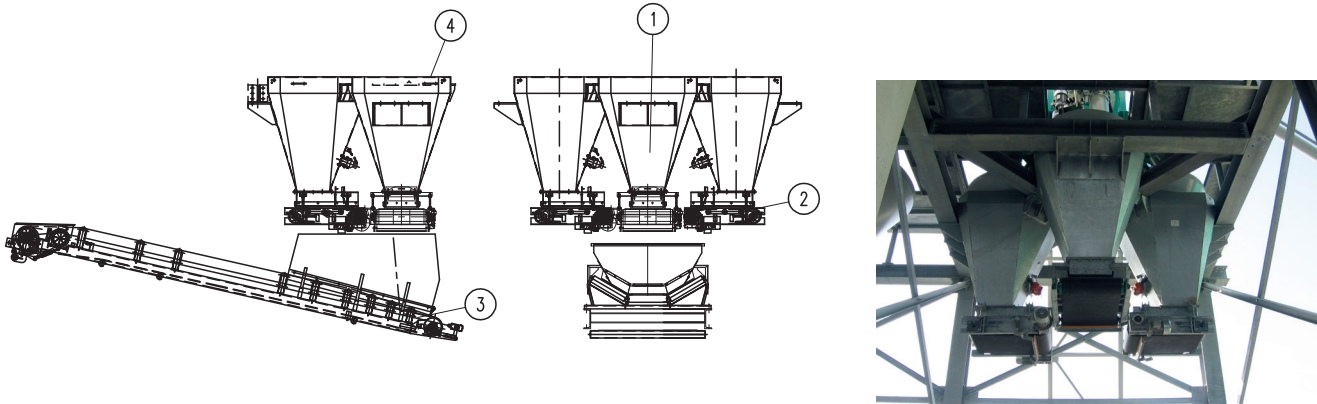

## OVERHEAD COLOR MIX

The system is composed of an overhead trolley multi-compartment (1-4), for different colors. The overhead Color Mix runs on rails, between the mixer and the block machinery, downloading each color in the required proportions. The discharge of each color is allowed by a timed hydraulic gate or by a weight deduction system.

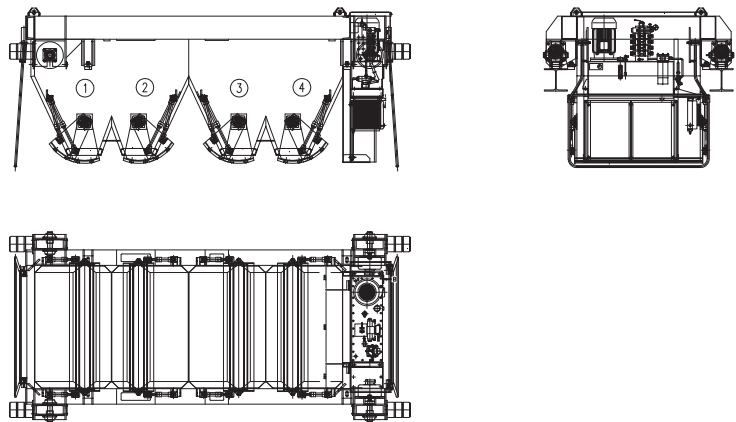

## MIXING



# IMER GROUP MIXERS

## *RELIABILITY AND PERFECT MIXING*

**Mixing** is the most important phase in the concrete production process.

Indeed concrete **quality** and **costs** depend on **mixing** quality.

**IMER GROUP mixers** are the result of the meticulous and systematic analysis of problems concerning mixing materials of different sizes, shapes, consistency and specific weight.

Extremely **sturdy**, **reliable** and **versatile**, mixers are built with wear-resistant materials that allow maintenance reduction and can be applied in multiple production fields.



## PLANETARY MIXERS

# ORUMS

ORU MS planetary vertical mixers with coaxial motor can quickly mix any type of concrete with excellent results: **dry**, **semi-dry** or **plastic**.

They are used in the ready-mix and precast sectors and in the production of materials such as glass, ceramics, refractory material, cold asphalt, etc.

## HORIZONTAL DUAL AXIS MIXERS

# ORUMD

Thanks to our experience in the pre-mixing sector and to the introduction of technological innovations, the horizontal dual axis mixing line is able to pack **any type of concrete** (civil and industrial constructions, dams, lightweight concrete with low specific weight additives, mixes for foundations and stabilizers).

The **ORU MD** mixer line is equipped with two horizontal mixing axes rotating in sync in opposite directions.





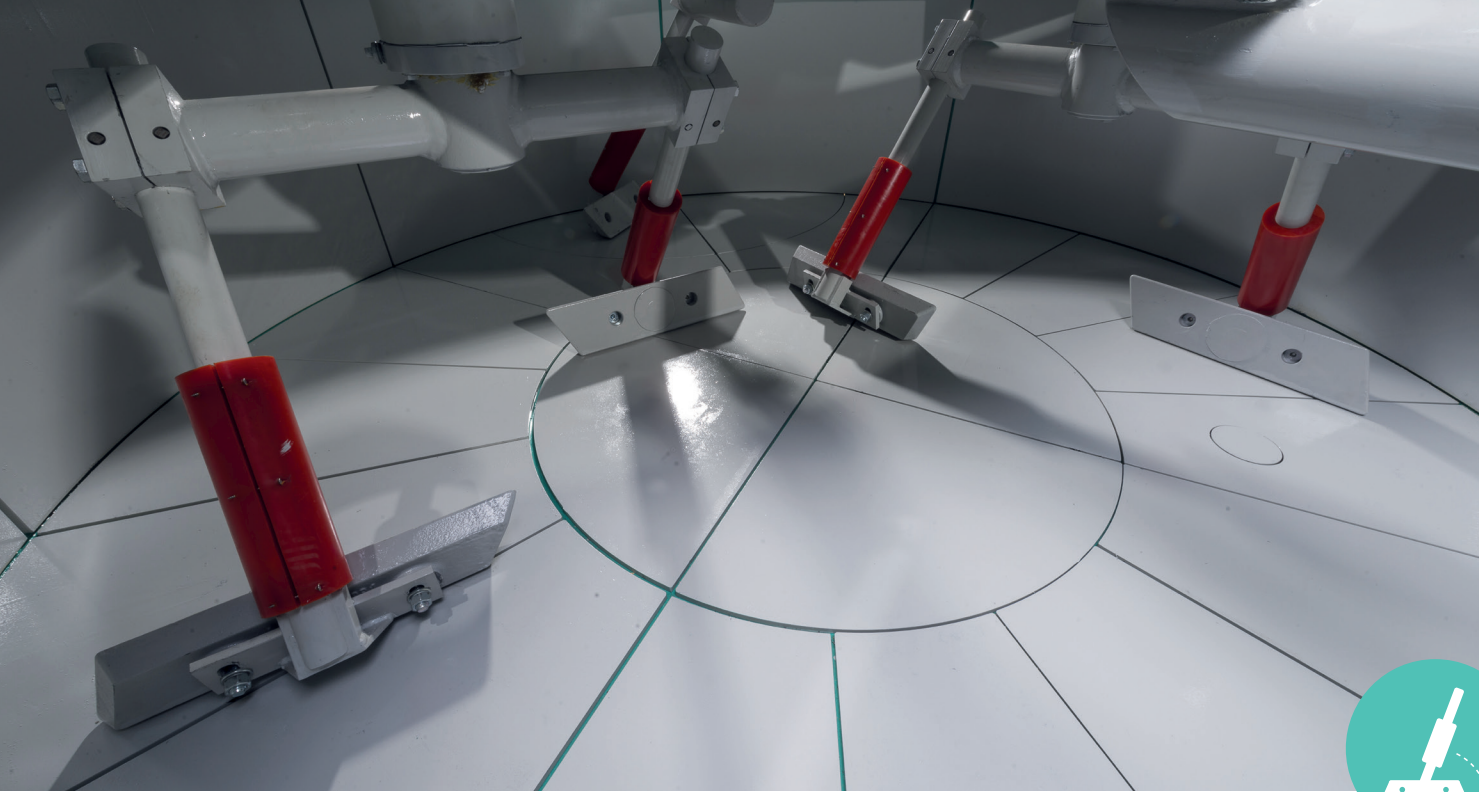

# ORUMS

## SCRAPER AND MIXER BLADES

The **blade angles of incidence** and **profiles** were carefully designed to best exploit the power available, reducing mixing and discharge times to a minimum.

The entire material mass is involved thanks to the ideal angle, guaranteeing high mix homogeneity. The blades are reversible to extend their working lives. Significant time savings and less wear are due to such an efficient mixing system.

Each mixing star holds **two or three** special steel **arms** with high elasticity, according to the model.

The **rounded arm shape** contributes to the lack of material accumulation during the mixing and discharge phases. The arms are coated with **wear-resistant lining** that guarantees “almost eternal” durability. Thanks to the fall stop system, arm regulation is simple, fast, perfect and safe. The **scraper blades** actively contribute to mixing, preventing material accumulation on the walls.

All blades can be made of **cast iron** or, upon request, **elastomer** with surface coating. Blade rotation and revolution speeds were designed to provide high productivity without creating material segregations with different specific sizes and weights.

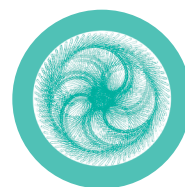

**Material movement in the tanks is gentle, gradual and continuous.**

The graphic representation of a computerized technical analysis indicates how, after just one gear motor revolution, the blades fully cover the entire mixing tank surface in their movement.



# ORU MS P

## ***(ORU MS 500/330P AND 750/500P)***

These two machine models are dimensionally and externally the same as standard mixers of the same size, but have a different internal layout.

The standard planetary mixer mainly mixes concrete with two principles:

- Revolution from the outside in and vice versa;
- Overturning material from the bottom up.

In addition to these two principles, **“P” version** machines apply a centrifugal action able to move material from the top down.

Thanks to a whisk, the **“P” version** is able to obtain a **very homogeneous mix** with lightweight aggregates, especially suited for bi-component objects and, specifically, finishing mixes for prestigious or visible surfaces.

Installed power and mixing times do not vary from the standard range.

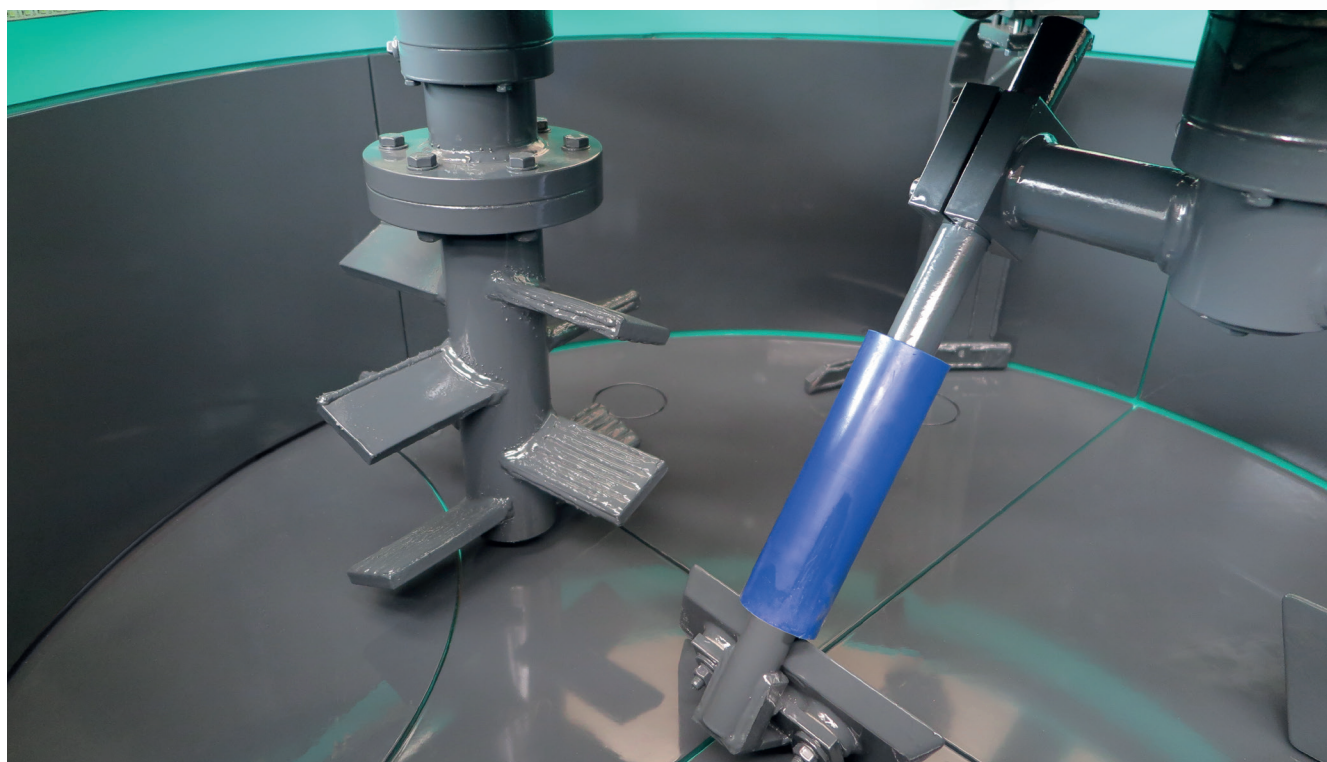
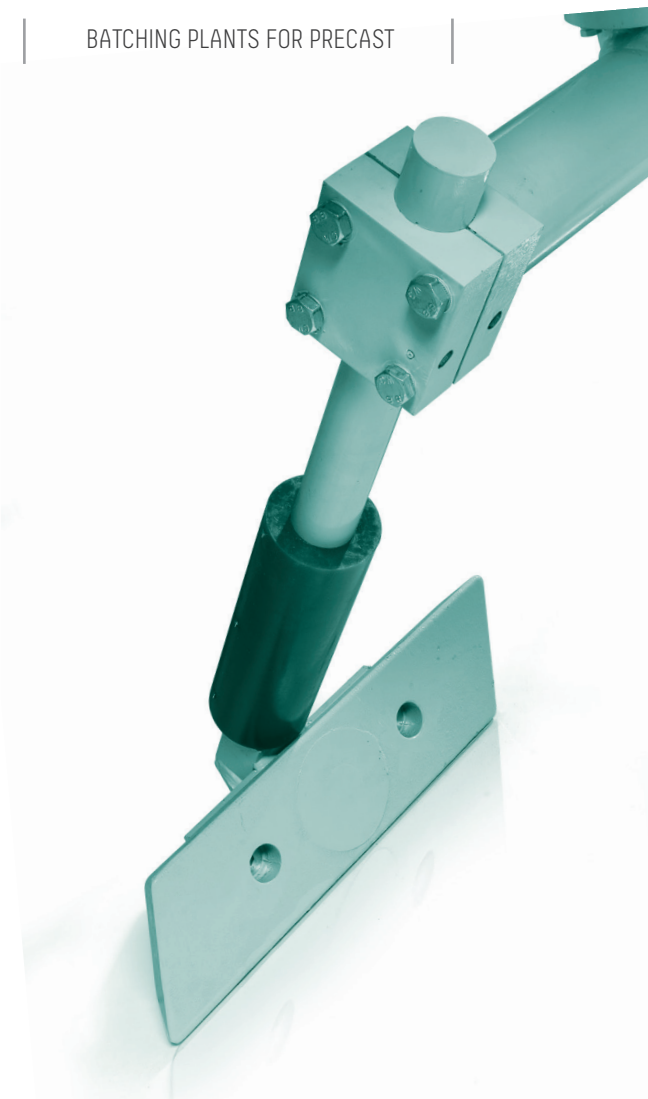





## WATER EMISSION

The machine is set to be equipped with almost any automatic water dosing system (by weight or volume).

**Water is emitted** by a series of adjustable nozzles that distribute water over the entire mix surface.

Recycled **water** is directly emitted by a blade sprayer using a timed dosing system (upon request).

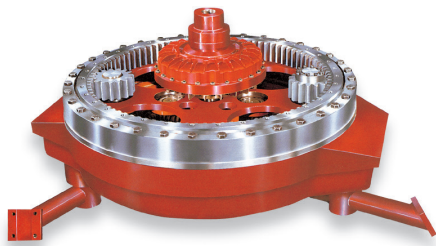

## HYDRO-DYNAMIC JOINT

The oil bath planetary gear motor with hydro-dynamic joint is the heart of the machine. Indeed, the oil, subjected to a continuous

flapping by a special device, is forced upward within the gearcase, thus ensuring a constant lubrication of all moving devices.



## WASHING SYSTEM

This equipment is available in a manual and an automatic version. The washing system, used during the cycle phases, allows the mixing of concretes with different colors or mix designs avoiding the

contamination of the batches. The frequent use (several times a day) makes the cleaning process at the end of the working day easier and more efficient.

## DISCHARGE

The mixer **discharges** through a circular section door driven by an oil hydraulic cylinder. The door seal is made up of polyurethane gaskets. The door can be manually opened by a hydraulic pump in the event of emergency.

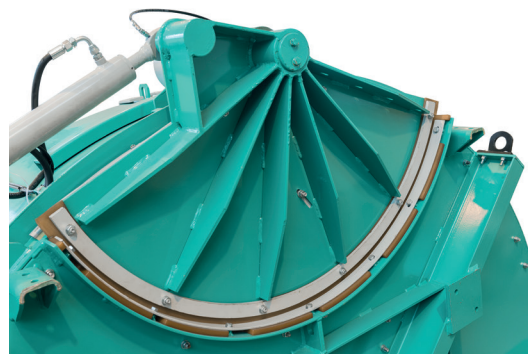



## CLEANING AND MAINTENANCE EASE

The wide opening angle on the covers permits easy access to the mixer interior. The lack of sharp corners and the rounded shape of the arms permit easy and fast cleaning.



## MOISTURE MIX PROBE

For automatic water dosing control.



## SAFETY SYSTEM WITH KEY CODE

Safe access door opening device.

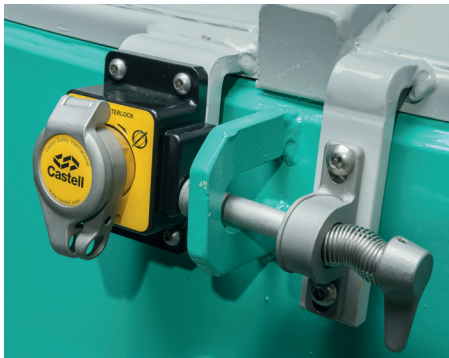

## CONCRETE PICKING DEVICE

For laboratory tests and special products (optional).

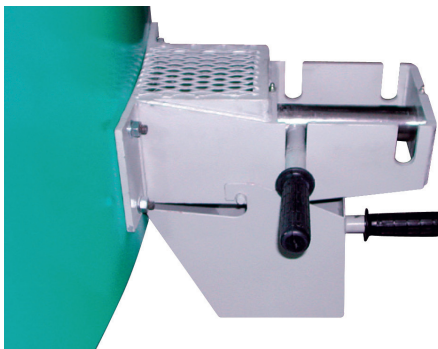

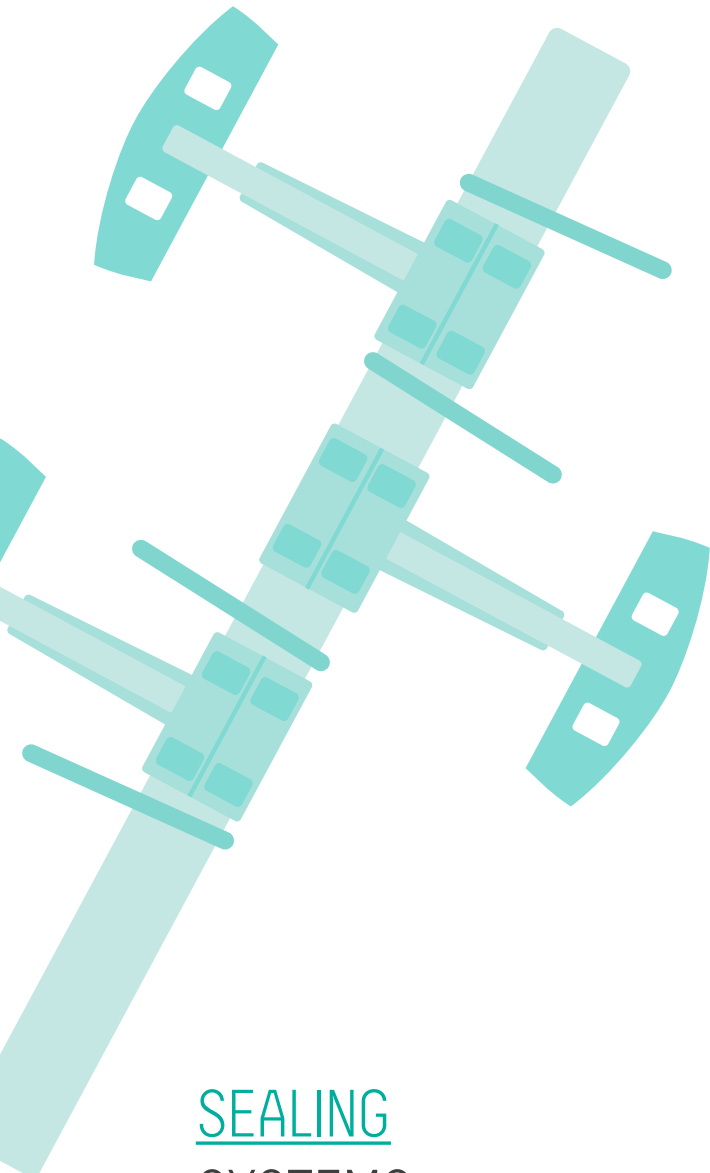

# ORUMD

## MIXING TANK

The mixing tank is expanded in relation to the amounts to be mixed to quickly obtain a high quality mix.

The mixing tank is made with **larger press-bent edges** to simultaneously provide the structure with sturdiness and elasticity.

The tank lining is made up of small bolted and interchangeable elements, made of **special wear-resistant steel**. Their rotation in the various positions significantly lengthens working life.

## SEALING SYSTEMS

The sealing systems installed on our machines' mixing axes are fully reliable. The automatic and centralized lubrication system, equipped with 4 independent pumps, is highly efficient and its action, combined with our sealing system, significantly reduces maintenance.

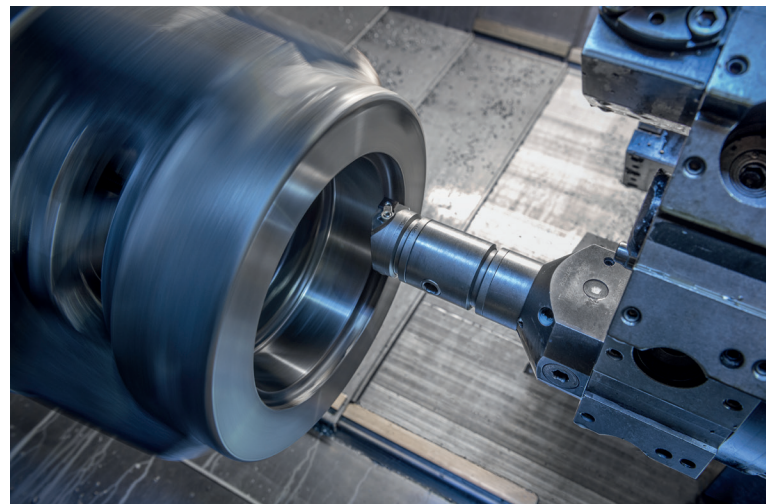

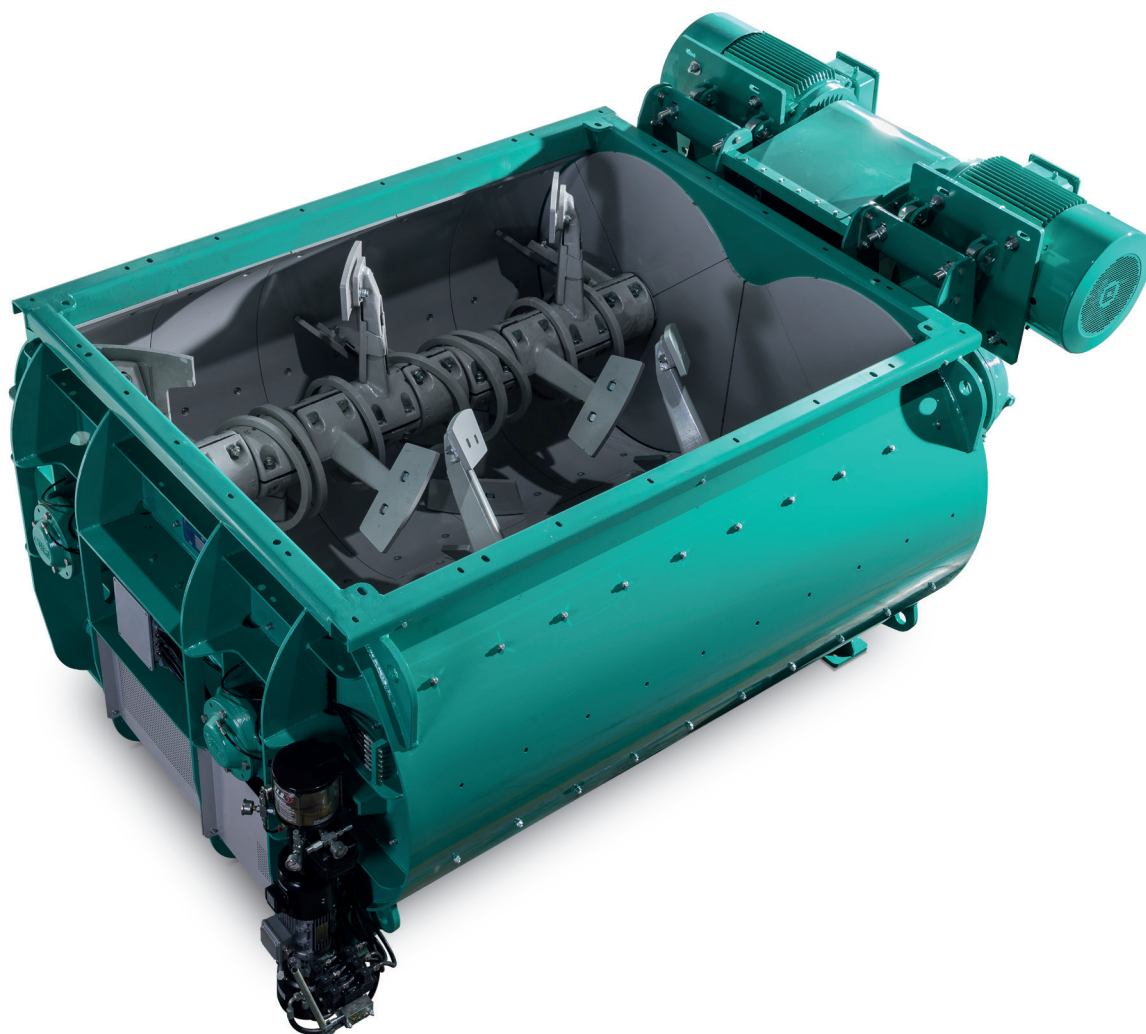

## MIXING BLADES AND ARMS

The **arms** are protected by easy-to-replace **wear-resistant plates** that help to improve mixing, thanks to the larger contact area, while they avoid arm wear during the pre-mixing process.

The blades, installed on the arms, are made of **anti-wear high-resistant steel** with a profile designed to **optimize performance** and reduce mixing time.

The **blade and arm tilt** causes the mix to move according to two counter-rotating propellers, partially overlapping, to obtain completely forced mixing, both horizontally and vertically.

**Any lightweight material centrifuge and floating separation phenomenon is excluded.**



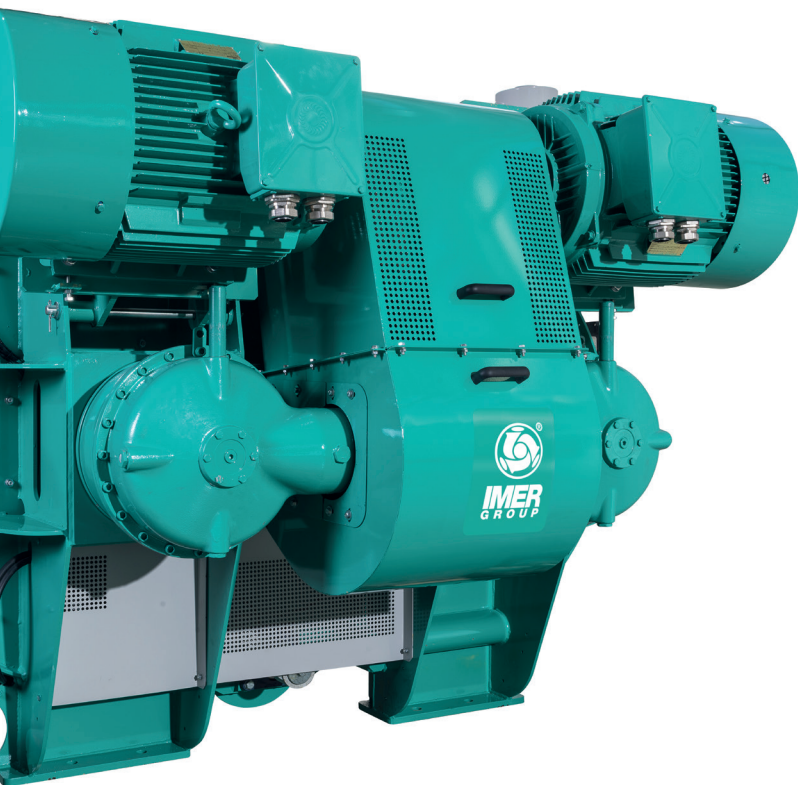

## GEAR MOTORS

Gear motors are equipped with an infeed pinion set with an expanded service factor to eliminate any possible overheating even in heavy-duty work conditions.

## DISCHARGE DOOR

The discharge door is equipped with interchangeable lining, adjustable contrast blades and a gasket system able to guarantee an excellent sealing even with very fluid mixes. The door extends over the entire length of the mixing tank and permits full and fast discharge. The door can be manually opened by a hydraulic pump in the event of emergency.



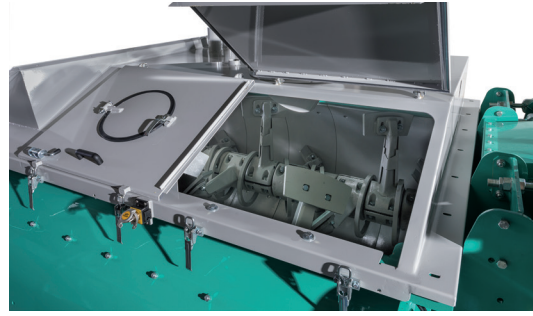
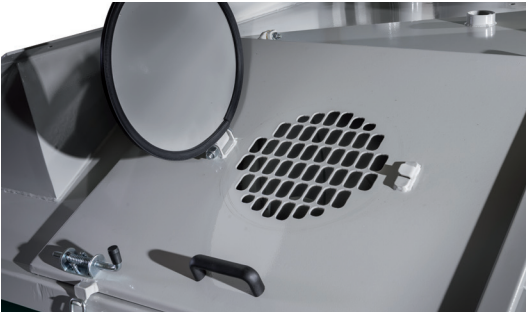

## OPENINGS AND INSPECTION DOORS

Inspections and maintenance are made easy by the large openings and doors with protection grates. All elements meet the most stringent international safety regulations.

## 4-PUMP LUBRICATION SYSTEM



## WATER SYSTEM

The system permits even water distribution over the entire surface, guaranteeing fast mix homogenization.



## COMPLETE LIST OF ACCESSORIES FOR ORU MS MIXER

- AUTOMATIC HIGH PRESSURE MIXER CLEANING SYSTEMS
- AUTOMATIC MICROWAVE MOISTURE DETECTION SYSTEMS
- HOT WATER OR STEAM HEATING SYSTEMS
- COOLED WATER OR ICE COOLING SYSTEMS
- AGGREGATE/SKIP/CONVEYOR BACKUP HOPPER
- CONCRETE BACKUP HOPPER
- ADDITIVE SYSTEM BY WEIGHT, VOLUME OR TIMED
- LIQUID OR POWDER COLOR DOSING SYSTEM
- DUST VACUUM AND RECOVERY SYSTEM
- UP TO TWO ADDITIONAL CIRCULAR SECTION DISCHARGE DOORS DRIVEN BY OIL HYDRAULIC CYLINDER WITH PARTIAL OR FULL OPENING
- AIRBAG
- CONCRETE SAMPLING DEVICE
- HARD SINTERED METAL BASES AND CASE
- MIXING BLADES WITH ELASTOMER OR VIDIA METAL SURFACE COATINGS
- METALLIC FIBER DOSING SYSTEM
- PLASTIC FIBER DOSING SYSTEM
- TEMPERATURE PROBES
- 1- OR 2-COMPARTMENT CEMENT SCALE



## Technical specifications

ORU MS RANGE		ORUMS 500/330	ORUMS 500/330P	ORUMS 750/500	ORUMS 750/500P	ORUMS 1200/800	ORUMS 1500/1000	ORUMS 2250/1500	ORUMS 2250/1500S	ORUMS 3750/2500
Load capacity	yd <sup>3</sup>	.65	.65	1	1	1.5	2	3	3	5
Load capacity	tons	.9	.9	1.3	1.3	2.1	2.6	4	4	6.8
Soft yield	yd <sup>3</sup>	1	1	1	1	2	2	3	3	5
Vibrated yield	tons/yd <sup>3</sup>	278	278	421	421	674	843	1,264	1,264	2,107
Mixing and discharge time	sec.	45	45	45	45	46	45	60	45	60
Stars and blades	n.	1x3	1x2	1x3	1x2	1x3	2x2	2x2	2x2	3x2
Scraper blades	n.	1	1	1	1	1	1	1	1	1
Tangent blades	n.	-	-	-	-	-	1	1	1	2
Differential case	r.p.m.	16	16	16	16	15	12	10	12	10
Star	r.p.m.	46	46	46	46	44	42	35	42	35
Mixing power	hp	20	20	25	25	40	60	74	100	177
Oil hydraulic unit power	hp	3	3	3	3	4	4	4	4	4
Weight	tons	2	2	2	2	4	5	6	6	10
Whisk (r.p.m.)	r.p.m.	-	150	-	150	-	-	-	-	-





## COMPLETE LIST OF ACCESSORIES FOR ORU MD MIXER

- AUTOMATIC HIGH PRESSURE MIXER CLEANING SYSTEMS
- AUTOMATIC MICROWAVE MOISTURE DETECTION SYSTEMS
- HOT WATER OR STEAM HEATING SYSTEMS
- COOLED WATER OR ICE COOLING SYSTEMS
- AGGREGATE/SKIP/CONVEYOR BACKUP HOPPER
- CONCRETE BACKUP HOPPER
- ADDITIVE SYSTEM BY WEIGHT, VOLUME OR TIMED
- LIQUID OR POWDER COLOR DOSING SYSTEM
- DUST VACUUM AND RECOVERY SYSTEM
- BLADES THICKENED WITH 500 HB OR HIGH-RESISTANT CHROME CAST IRON
- AIRBAG
- AUTOMATIC AND CENTRALIZED LUBRICATION SYSTEM
- TEMPERED STEEL TANK LINING
- CLEANING RINGS
- SECOND DOOR INSTALLATION UPON REQUEST

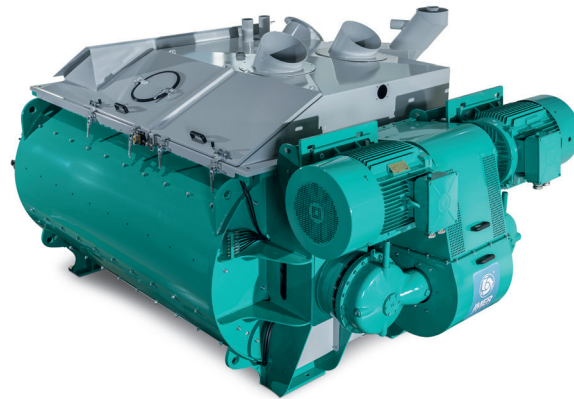

### Technical specifications

ORU MD RANGE		ORUMD 3000/2000	ORUMD 3750/2500	ORUMD 4500/3000	ORUMD 5000/3350
Load capacity	yd <sup>3</sup>	4	5	6	6.5
Load capacity	lbs	5	6.5	8	9
Vibrated yield	yd <sup>3</sup>	3	3	4	4
Cycle time	sec.	55	60	65	70
Max aggregate size	in	0-6	0-6	0-6	0-6
Mixing power	hp	2x50	2x60	2x73	2x87
Mixing blades	n.	12	16	20	20
Oil hydraulic unit	hp	2	2	2	2
Skip load capacity	yd <sup>3</sup>	4	5	6	6.5
Standard skip speed	yd/min	38	38	40	40
Skip power	hp	40	49	60	74
Weight (without Skip)	tons	8	9	10	10.5



# MANAGEMENT SYSTEMS



The IMER Group management units for the concrete batching plants are “user friendly” systems able to plan, control, automatically coordinate all the plant operations and to constantly check the production process. Our management systems are also available in a touch screen version.



## MOISTURE MIX PROBE

The moisture mix probe installed on the bottom of the mixer measures and displays the percentage of moisture contained in the mix. A correct positioning contributes towards a correct measurement of moisture. To ensure a precise w/c ratio it is very important to interface the probes with an automation system able to accurately process the data. Thanks to the specific software for the microwave reading of the moisture probe, it is possible to achieve a high level of water metering accuracy.



# HPS 2100-P / 3100-P

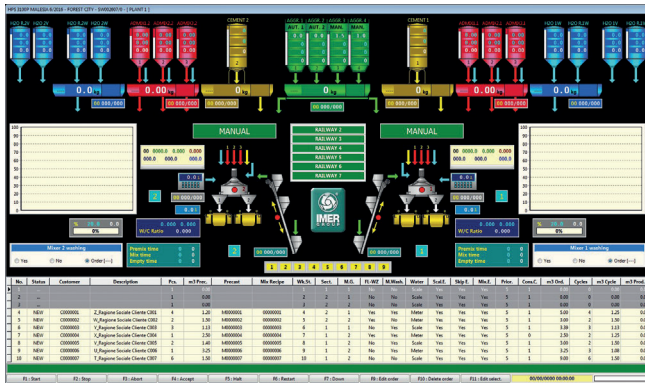

Customized software solution for the automation of the most advanced concrete production for the precast industry.

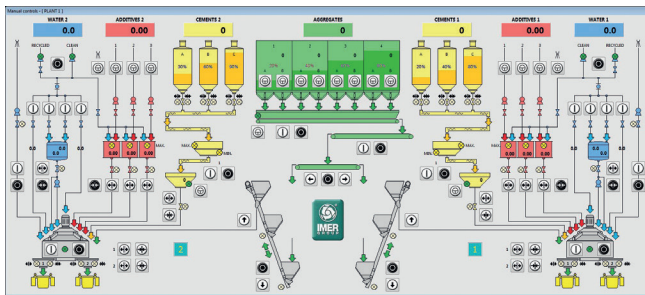

User-friendly interface. Extremely intuitive and simple to use.

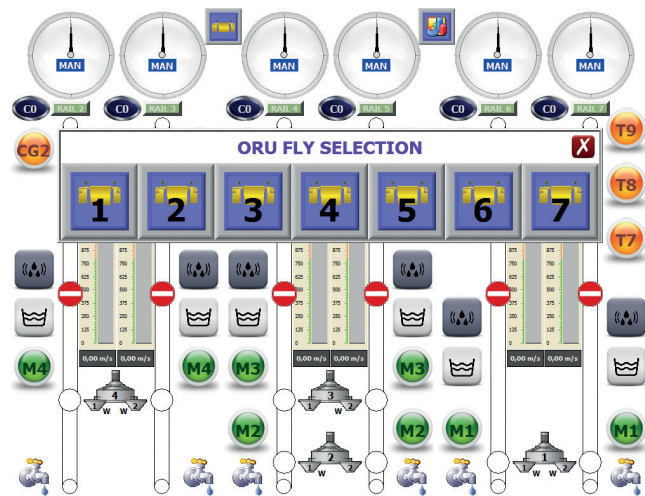

DA-MULTI Management Unit for one or more overhead skips.

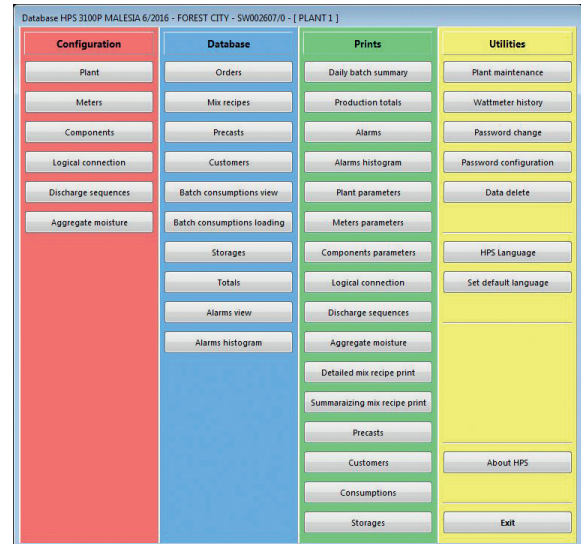

The HPS Database application (Data management) provides the following functions: Management of the plant configuration (operating parameters, meters, components, mix recipes, etc.); Processing of the data stored during the batches (consumptions, storage, production totals, etc.); Historical data display (alarms, batches, etc.); Printouts (configuration, consumptions, alarm reports, batches, totals, etc.); Data backup and restore procedures called HPS Backup Files and HPS Restore Files are present, which allow the operator to save the configuration data as well as the historical data. Whenever necessary it is possible to restore the previously saved files.

DA-MULTI is an automatic/manual management system of overhead trolley for stationary or mobile discharging stations, equipped of collision avoidance systems. The skip is equipped with plc on board and radio connection, receives calls from the HPS control system and manages the required operations independently. The system is fitted with a central control panel equipped with touch-screen terminal where all the functions are displayed:

- running operations
- real time diagnosis
- reporting of any possible anomalies during the working operations
- it is possible to modify all the operating parameters of the skip from the touch-screen terminal.

DA-MULTI Management Unit is completely customizable according to the production needs.



TOLL FREE: **800.275.5463**  
**WWW.IMERUSA.COM**



TOGETHER WE BUILD

**IMER USA, Inc.**  
221 West Hampton Place  
Capitol Heights, MD 20743  
Tel. (800) 275-5463 - Fax (301) 336-6687  
[www.imerusa.com](http://www.imerusa.com)



Le Officine Riunite - Udine S.p.A. reserve the right to change the information contained herein without prior notice when they consider it justified. The data and dimensions are therefore not to be considered as binding. The illustrations may include accessories and therefore they could be slightly different from the standard versions of the equipment.

© Copyright by Le Officine Riunite - Udine S.p.A. 2017